

OPERATING INSTRUCTIONS
FOR
AMPROBE®
SPIKE-SAG-SURGE
RECORDER
MODEL LAS-800

See Precautions for Personal and Instrument
Protection on Page 3.

See Limited Warranty on Page 2.

Contents

Limited Warranty	2	Typical Strip Chart Readings	8
Precautions for Personal & Instrument Protection	3	Operation - Mechanical & Electrical	10
Introduction	3	Interpreting the Strip Chart	12
Specifications	4	Appendix A	14
Operating Procedure	5	Definition of Spikes	14
Unpacking	5	Definition of Sags & Surges	14
Battery Replacement	5	Appendix B	15
Side Panel Controls, Indicators & Connections	7	Meaning of "Peak Sensing - Scaled to RMS"	15
		Nomenclature	16



A United Dominion Company
Miami, Florida 33150

LIMITED WARRANTY

Congratulations! You are now the owner of an AMPROBE® instrument. It has been quality crafted according to quality standards and contains quality components and workmanship. This instrument has been inspected for proper operation of all of its functions. It has been tested by qualified factory technicians according to the long-established standards of **AMPROBE INSTRUMENT**.

Your **AMPROBE** instrument has a limited warranty against defective materials and/or workmanship for two years from the date of purchase provided, in the opinion of the factory, the instrument has not been tampered with or taken apart.

Should your instrument fail due to defective materials, and/or workmanship during the two-year warranty period, return it along with a copy of your dated bill of sale which must identify instrument by model number and serial number.

IMPORTANT:

For your protection, please use the instrument as soon as possible. If damaged, or should the need arise to return your instrument, it must be securely wrapped (to prevent damage in transit) and sent prepaid via Air Parcel Post insured or UPS where available to:

**Service Division
AMPROBE INSTRUMENT
630 Merrick Rd. (Use for U.P.S.)
P.O. Box 329 (Use for P.P.)
Lynbrook, N.Y. 11563-0329**

Outside of the U.S.A. the local Amprobe representative will assist you.

Above limited warranty covers repair and replacement of instrument only and no other obligation is stated or implied.

Serial number is located on the scale plate of the unit.

PRECAUTIONS FOR PERSONAL & INSTRUMENT PROTECTION

1. Read these instructions thoroughly and follow them carefully.
2. In many instances you will be working with dangerous levels of voltage and/or current, therefore, it is important that you avoid direct contact with any uninsulated, current-carrying surfaces. Appropriate insulating gloves and clothing should be worn.
3. Before connecting or disconnecting the meter to or from the circuit to be tested, turn off all power to the circuit.
4. Before applying test leads to circuit under test, make certain all switches are set to proper range and function.
5. Before using electrical instruments or tester for actual testing, the unit should be checked on a known live line to make certain it is operating properly.
6. If the instrument should fail to indicate, do not touch circuit until you have checked to see that all instrument switches are in proper position and instrument has been checked on a known live line.

IMPORTANT: Failure to follow the instructions or to observe the above precautions may result in personal injury and/or damage to the instrument and/or accessories.

INTRODUCTION

Power Line Disturbances (PLD's) can cause modern electronic equipment, especially computers, to malfunction. Common types of power line disturbances are voltage dips (SAGS), voltage increases (SURGES), and high frequency impulses (SPIKES). Even though monitoring for these disturbances could be a costly and time-consuming process, it is important to monitor the power line for PLD's to determine if protection is necessary and, if so, the type.

The AMPROBE LAS-800 strip chart recorder offers an easy-to-use, affordable solution to monitoring PLD's. Through the use of advanced solid state circuit design, the LAS-800 can monitor the power line for all three types of disturbances and display the results on a strip chart.

The AMPROBE LAS-800 can easily be moved from site to site because of its rugged design and small size.

SPECIFICATIONS

Ranges: 0-220/440/880 volts, full scale, 50 or 60Hz.

These full scale ranges were selected so that "Nominal" power line voltages (120, 240, 480) would fall approximately in the middle of the range allowing for a wide, SPIKE-SAG-SURGE threshold adjustment. (0-Full Scale for Surge and Spike, 0-half scale for SAG.)

Nominal voltage ranges are average responding, calibrated in terms of RMS.

Spike-Sag-Surge voltage ranges are peak sensing, but scaled in terms of RMS. (To obtain the true magnitude of a spike, multiply the spike reading by 1.414. For further explanation, see appendix B.)

Accuracy: Nominal voltage ranges, $\pm 3\%$ of Full Scale. Sag and Surge, $\pm 3\%$ of Full Scale $\pm 2\%$ of reading based on sinusoidal waveforms.

Note: Sag and Surge response time is $\frac{1}{2}$ cycle of 50 or 60Hz sinewaves.

Spike, $\pm 3\%$ of Full Scale $\pm 10\%$ of reading. Spike accuracy is specified for a rectangular pulse whose rise time is greater than 35 nanoseconds and whose sum of rise time plus peak duration is at least 350 nanoseconds. Accuracy diminishes for narrower spikes.

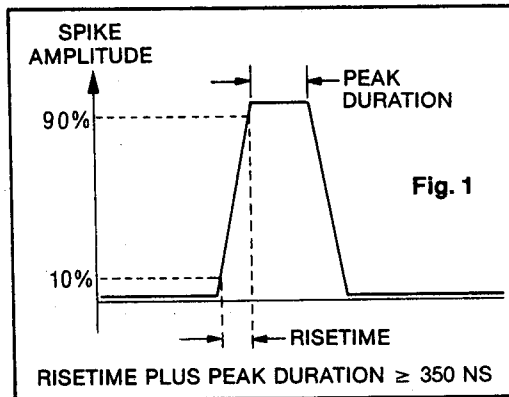

When spike measurements are made, the fundamental 50 or 60Hz sine wave is filtered out by a high-pass filter to allow measurement of the spike itself. This high pass filter has an attenuation of approximately 50% at 1000Hz and approximately 100% at 50/60Hz.

Input Impedance: 220 Volt Range - 387Kohms ($\pm 1\%$)/15 pf.
440 Volt Range - 784Kohms ($\pm 1\%$)/15 pf.
880 Volt Range - 1580Kohms ($\pm 1\%$)/15 pf.

Threshold Adjustment Range: Surge and spike are adjustable from 0% to 100% of **Full Scale**. Sag is adjustable from 0% to 50% of **Full Scale**.

Battery Power: Two 9 volt alkaline batteries Model MN1604 will provide up to one hour of power to maintain LED's memory during a Line Power failure.

Low Battery Indicator: When "on", the two 9 volt alkaline batteries should be replaced

Operating Temperature Range: 32°F to 122°F; (0°C to 50°C)

Chart Speed: 12" / Hr., Model 800S

Line Power: 120 volts AC, 60Hz., 9 watts.

Note: 50Hz available on special order.

OPERATING PROCEDURE

Introduction

This section describes how to use your LAS-800 recorder. Even though you may have used a strip chart recorder before, we suggest that you take the time to read this material carefully.

Unpacking

Your LAS-800 has been shipped with two test leads (one red and one black), a line power cord, one 30-foot roll of chart paper #800S, and this manual. Check the shipment carefully and immediately contact **AMPROBE** if anything is missing or damaged in shipment.

Battery Installation or Replacement

The LAS-800 requires two 9V alkaline batteries Model MN1804 (not included) to supply one hour of "memory" for LED indicators.

WARNING

To avoid possible electrical shock, remove line power cord and test leads from instrument before replacing batteries

Use the following procedure to install or replace the batteries:

1. Remove line power cord from external connections first, then from LAS-800 line cord connector.
2. Remove test leads from external connections first, then from LAS-800 input terminals.
3. Insert small screwdriver into slot area indicated by arrow and pry battery cover up. Remove old batteries (Fig. 2)
4. Carefully pull battery clips free from battery terminals (if replacing battery) and attach to new batteries.
5. Slide batteries into holder according to label in well. Clip down.
6. Snap cover into place.

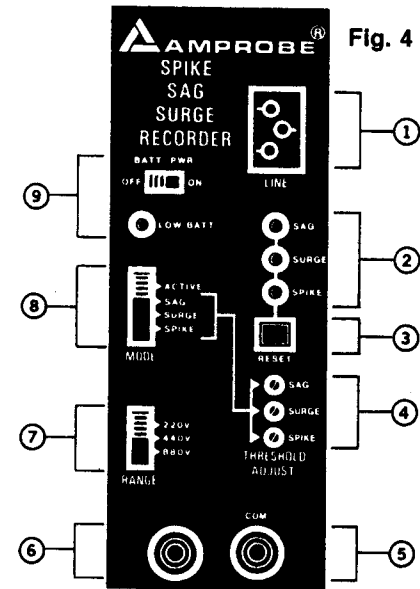
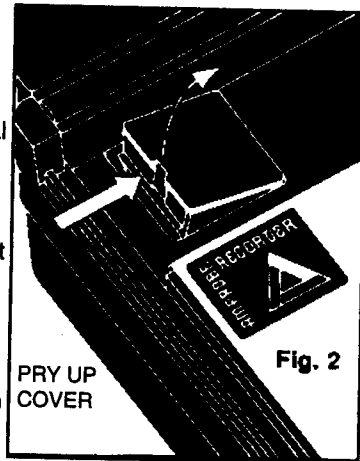

SIDE PANEL CONTROLS, INDICATORS AND CONNECTIONS

Item No.	Item	Function
1	Line Connector	Provides connection of female end of power cord to LAS-800.
2	LED (light emitting diode) Indicators	When lit, advises user that event has occurred.
3	Reset Switch	When depressed, causes LAS-800 internal circuits to reset, turning LED (2) indicators off.
4	Threshold Adj.	Screwdriver adjustment to set threshold levels where LED's will come on and recorder will print value of corresponding event.
5	Common Input Connector	Test lead connector used as the low or common input for all measurements (black lead).
6	Volts Input Connector	Test lead connector used as the high input for all voltage measurements (red lead).
7	Range Switch	Selects measurement range.
8	Mode Switch	Active position - LAS-800 will record all power line activity. Sag, surge, spike, position allows LAS-800 users to set thresholds via (4) screwdriver adjustments on recorder side panel.
9	Battery Power Switch* and LED	Battery power switch* connects batteries to LED memory circuit. Low battery LED indicates when 9V batteries need replacement.

*Note: Switch should be in off position when recorder is not being used.

INPUT WAVEFORM

NO INPUT
customer adjustable threshold settings.
Example: 220V Range
110V nominal
Sag — 85% nominal
Surge — 115% nominal
Spike — 20% nominal

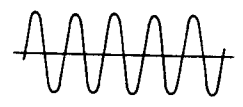

60Hz 120V nominal
NO EVENTS

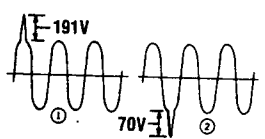

60Hz 110V nominal
with:
1. 191V SCALED SPIKE*
2. 70V SCALED SPIKE**
* Peak V of Spike = 191 x 1.414
** Peak V of Spike = 70 x 1.414
Refer to Appendix B.

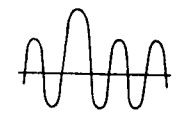

60Hz 110V nominal
with:
150V (RMS value) Surge
with no high frequency component.

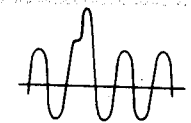

60Hz 110V nominal
with:
150V (RMS value) Surge
with 71V high frequency component (scaled).
Refer to Appendix B.

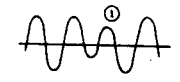

60Hz 110V nominal
with:
1. 70V (RMS) Sag

5/2.5 MINUTES

10/5

15/7.5

20/10

25/12.5

30/15

35/17.5

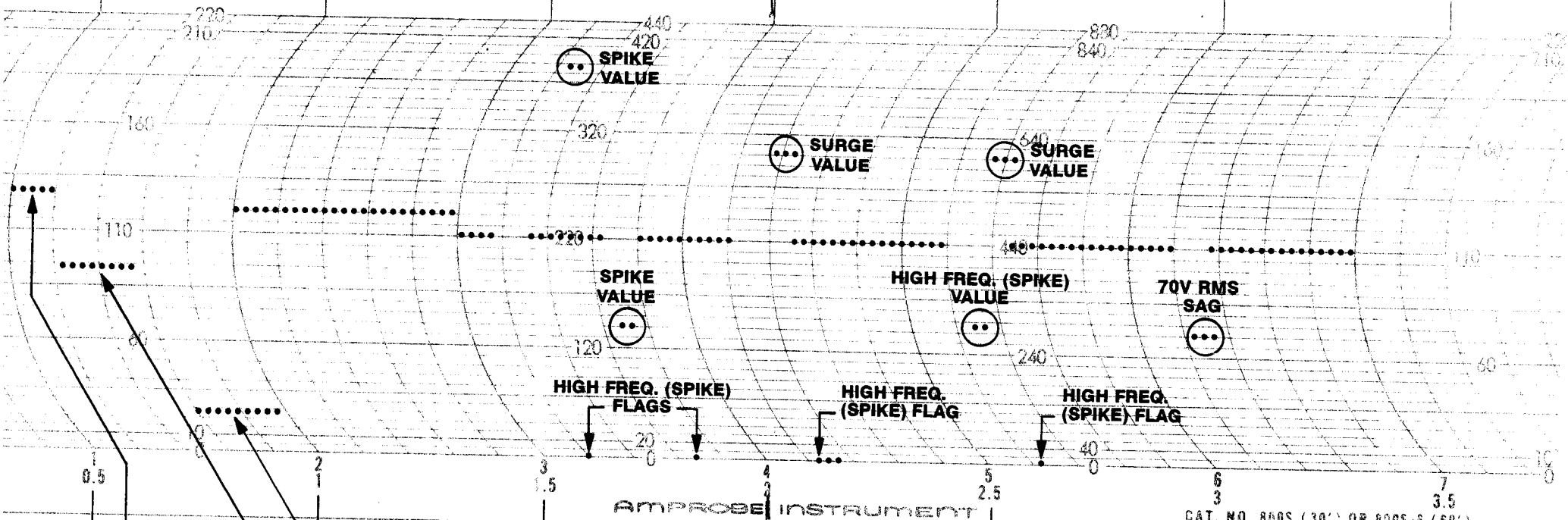

SWITCH SETTING

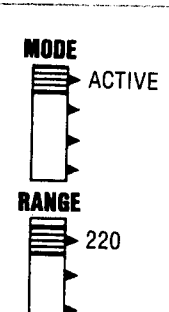
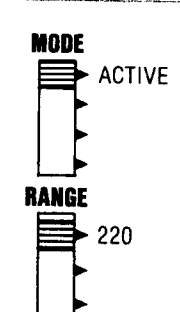
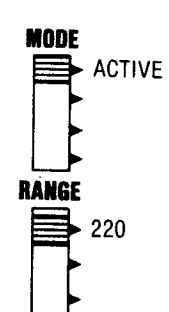
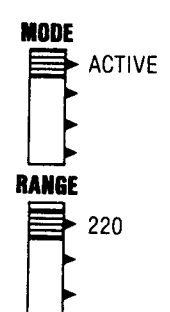
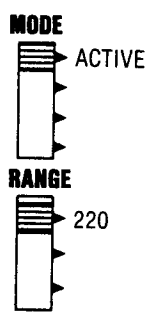
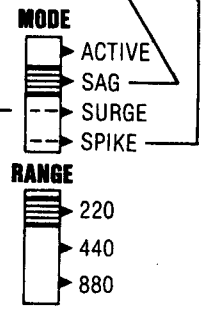

AMPROBE INSTRUMENT

CAT. NO. 800S (30') OR 800S-S (60')

OPERATION

1. Mechanical

- Observe location of recorder pointer. It should line up with the zero on the extreme right side of the scale. To make corrections, remove recorder top cover. Apply finger to star wheel located inside chart well. Turn star wheel until pointer lines up with zero. (Fig. 5)
- Connect female end of power cord to line connector.
- Connect black test lead to "COM" input terminal. Connect red test lead to the input terminal on the left.
- Be sure chart drive switch is in "OFF" position. (Fig. 6)

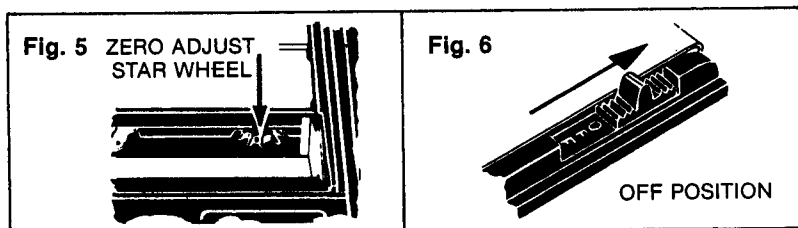

2. Electrical

Connect male end of power cord to line power.

Note: Spike, sag or surge LED's may be on at this time.

In the following steps you will be instructed to set threshold levels for spike, sag, and surge. Typical levels (set by user) are as follows:

Spike: $\geq 100\%$ of nominal.

Sag: 15-25% below nominal

Surge: 15-25% above nominal

Thus, (for 110 volt nominal) Sag = 82.5V - 93.5V; Surge = 126.5 - 137.5 and Spike ≥ 110 volts.

To establish these thresholds, proceed as follows:

- Move "range" switch to "220V".
- Move "mode" switch to "sag" position.
- Insert a small screwdriver into "threshold adjust" hole marked "sag".
- Turn screwdriver until recorder pointer indicates 82.5 - 93.5 volts.
- Move "function" switch to "surge" position.

- Repeat C & D for "surge" adjustment of 126.5 - 137.5 volts.
- Move "function" switch to "spike" position.
- Repeat C & D for "spike" adjustment of ≥ 110 volts.
- Move "mode" switch to "active" position.

Final preparation for the LAS-800 to record line disturbances:

- Remove metal top cover of recorder.
- Place chart, Model 800S, in the well at the top of the recorder.
- Unroll nine inches of chart with printed white side up.
- Slip leading edge of paper under the glass. Feed over capstan wheels and through slot in bottom of recorder. (Fig. 7)
- Line up time arrow with any time line on left of strip chart. This will synchronize the chart travel with the time lines on the chart paper. (Fig. 8)

Note: Make sure the holes on both sides of the strip chart engage the sprockets of the capstan wheels.

- Replace metal top cover. Position the "U" bend at the top of cover onto the metal projections of the chart well, then snap front down. Make sure strip chart is not binding with cover in place.
- Write time of start on strip chart through opening.

Connect test leads to power line. Move "Battery Power" switch to "on". Push reset button. All LED's should be off. Move chart drive switch down, exposing the word "on". (Fig. 9) The LAS-800 is now monitoring the power line for sags, surges and spikes.

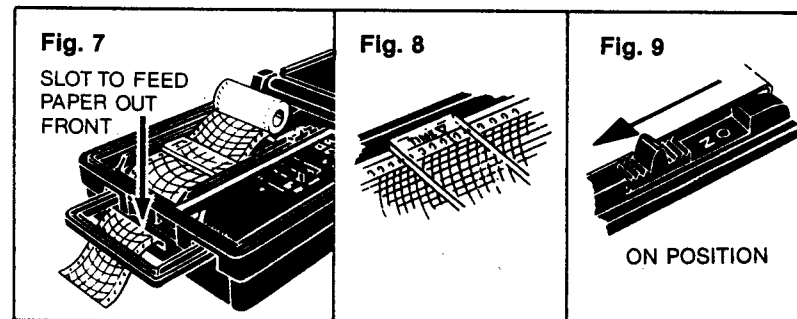

Note: The LAS-800 will record "Nominal" line voltage until an event is detected. When an event is detected, the corresponding red LED will light and the recorder will print out the event's magnitude. Upon completion of event printing, internal circuits are automatically reset to await the arrival of the next event. However, the red LED will remain on until "reset" switch is pushed. This feature allows the user to observe the recorder's side panel rather than scrutinize long lengths of chart paper for an event that may not have occurred.

INTERPRETING THE STRIP CHART

The strip chart produced by the LAS-800 is not a "real-time" graph. The chart moves at a rate of 12 inches per hour; that's 1/60 of an inch every 5 seconds. Thus, if the chart were simply a graph of voltage versus time, it would be very difficult to read any events less than a few seconds long. It would be impossible for your eye to tell the difference between a spike (which is much less than a millisecond long) and a short sag or surge (≥ 8.3 ms for a 60Hz AC wave).

On a real-time graph, it would be possible to tell a spike from a sag or surge only if the chart paper were moving much, much faster than 12 inches per hour— which we certainly wouldn't want, because the recorder would have to go through literally miles of chart paper per day.

To have charts of reasonable length and readable events, AMPROBE has devised a unique recording system. The LAS-800 chart recorder mechanism prints one dot every 5 seconds. In the absence of any power line disturbances, the recorder simply prints dots corresponding to the RMS magnitude of the measured line voltage; thus, the graph does vary in real time with any slow, long term changes in the line voltage. However, when power line disturbances occur, the disturbances are artificially "stretched out" to make them visible on the graph, and to make spikes distinguishable from sags and surges.

To distinguish among spikes, sags and surges, the following printing pattern was established:

- Spike** 3 dots – one dot at zero; next two dots indicate scaled magnitude of spike (See Appendix B)
- Sag** 3 dots indicating RMS magnitude of sag
- Surge** 6 dots – one dot at zero; next two dots indicate scaled magnitude of associated high frequency component followed by three dots indicating RMS magnitude of surge.

Usually, only one power line disturbance happens at a time. However, if multiple events occur, the sequence of printing will be spike, surge, then sag.

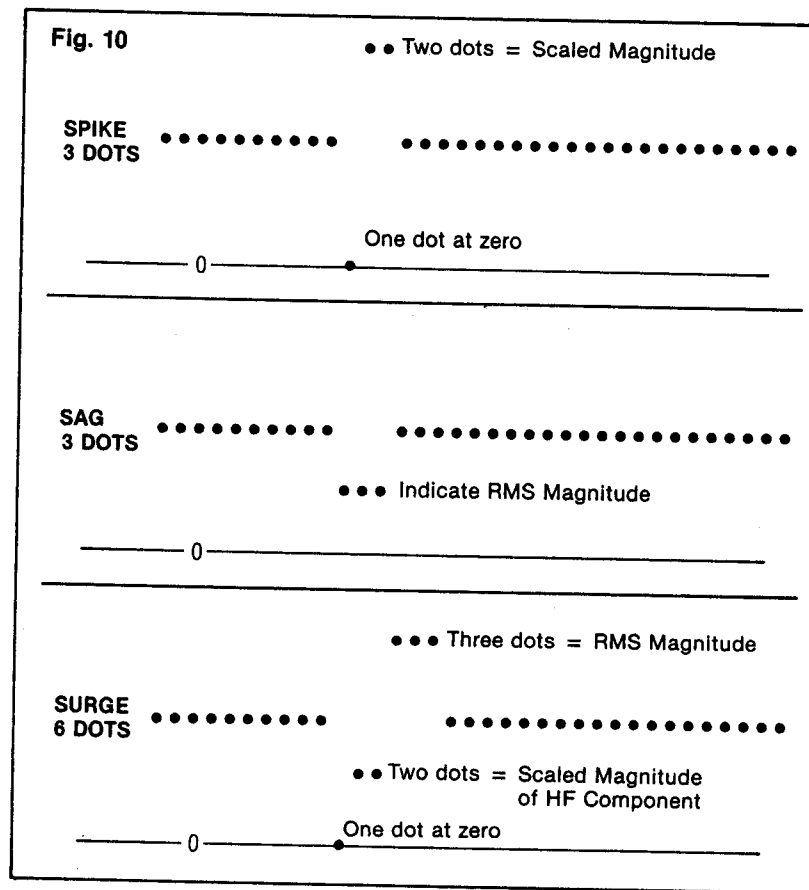

APPENDIX A

Definition of Spikes:

Spikes are pulses of very short duration and high peak value. These pulses can occur anywhere on the 50 or 60Hz waveform. Spikes usually last only for microseconds and usually don't have any noticeable effect on the RMS line-voltage measurement. However, the high peak voltage of some spikes can have disastrous effects on voltage-sensitive components in computers and other electronic equipment.

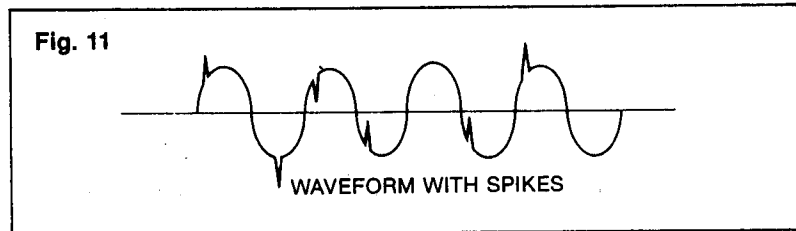

Definition of Sags and Surges:

Sags and surges are excursions of the line voltage which last long enough to be measured in terms of RMS on a half cycle or longer time base. They are caused by sudden load changes on the power line. Sags are usually caused by heavy loads being turned on, inrush currents of lights; drop-outs due to time lag of circuit breakers, etc. Surges are usually caused by loads being shut off.

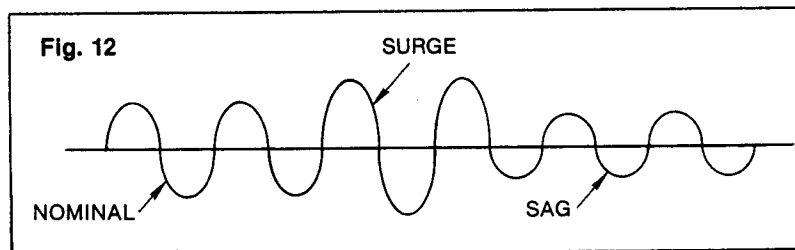

APPENDIX B

Meaning of "Peak Sensing, Scaled to RMS"

AC voltages are usually measured in terms of root-mean-square (RMS). For a perfect sine wave, the RMS voltage is equal to the peak voltage divided by 1.414. For example, a sine wave, whose RMS value is 110 volts, has a peak voltage of $1.414 \times 110 \text{ volts} = 156 \text{ volts}$.

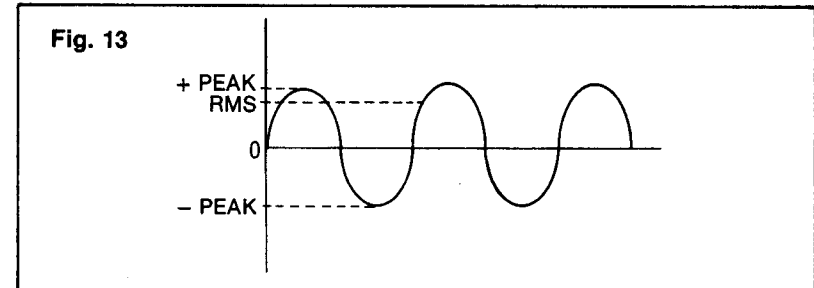

Although AC voltages are usually given in terms of RMS, most voltmeters do not actually measure RMS directly. Some voltmeters measure the peak voltage, which is then divided by 1.414 to give the RMS. The LAS-800 measures sag, surge, and spike voltages by this method.

This indirect method of measuring RMS is accurate for a perfect sinusoid (sine wave), but not very accurate for other kinds of waveforms. Fortunately, the line voltage is usually an almost perfect sine wave. Even during a typical sag or surge, the voltage waveform is still very close to sinusoidal.

Spikes, however, are another story. Depending on the exact shape of the particular spike, the RMS value may deviate significantly from the peak value divided by 1.414. The typical user does not need to know the exact RMS value since the destructive effects of a spike are usually a function of the spike's peak value, not its RMS value. What most users really need to know is the peak.

For the sake of consistency, on the LAS-800, spike measurements, like sag and surge measurements, are peak-sensing, scaled to RMS, i.e. a peak voltage measurement divided by 1.414. To get the peak spike voltage, simply multiply the spike reading by 1.414.

MODEL LAS-800 NOMENCLATURE

