

OPERATING INSTRUCTIONS
for
AMPROBE

AC TRUE RMS WATT CLAMP METER

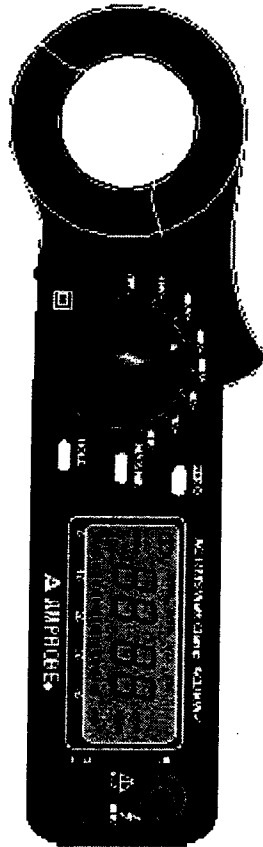

Model ACDKW-1



AMPROBE.
A United Dominion Company

Table of Contents

Features	2
Limited Warranty	3
Front Panel	4
Panel Description	4
AC Current Measurement	6
DC/AC Voltage Measurement	7
AC Single Phase (1 ϕ) Power/Watt Measurements	8
Calculation of Power Factor (PF) for AC Single Phase (1 ϕ) Power	9
Relative Reading Measurements	9
Holding the LCD Reading	9
Finding the Max/Min Value	9
To Recover from Auto-Power Off	9
Battery Replacement	10
Maintenance & Cleaning	10
Specifications	11
Appendix 1 - Measurement of Three Phase Wire (3 ϕ 3W) Power	13
Appendix 2 - Measurement of Four Phase Wire (3 ϕ 4W) Power	14

Features

1. Portable AC digital clamp meter for watt, current, and voltage measurement.
2. 30mm (1.1") jaw diameter
3. AC power measurement with 1W resolution.
4. One touch zero for W adjustment.
5. 30 minutes auto-power-off.
6. Large 3 3/4 digits LCD
7. Fast bargraph display (20 times/sec.) for transient observation.
8. Max or Min and Data Hold functions.
9. Easy single rotary switch for any function selection.

Limited Warranty

Congratulations! You are now the owner of an AMPROBE® instrument. It has been quality crafted according to the highest standards of quality and workmanship. This instrument has been inspected for proper operation of all its functions and tested by qualified factory technicians according to the long-established standards of AMPROBE®.

Your AMPROBE® instrument has a limited warranty against defective materials and/or workmanship for one year from the date of purchase provided that the seal is unbroken or, in the opinion of the factory, the instrument has not been tampered with or taken apart.

Should your instrument fail due to defective materials, and/or workmanship during the one year warranty period, return it along with a copy of your dated bill of sale which must identify instrument by model number and manufacturing number.

IMPORTANT: For your protection, please use the instrument as soon as possible. If damaged, or should the need arise to return your instrument, place it in a shipping carton packed with sufficient packing material. It must be securely wrapped. Amprobe is not responsible for damage in transit. Be sure to include a packing slip (indicating model and manufacturer number) along with a brief description of the problem. Make certain your name and address appears on the box as well as the packing slip.

Ship prepaid via Air Parcel Post insured or U.P.S. (where available) to:

Service Division
AMPROBE®
630 Merrick Road (For U.P.S.)
P.O. Box 329 (For Parcel Post)
Lynbrook, NY 11563-0329

Outside the U.S.A. the local Amprobe representative will assist you. Above limited warranty covers repair and replacement of instrument only and no other obligation is stated or implied.

Front Panel

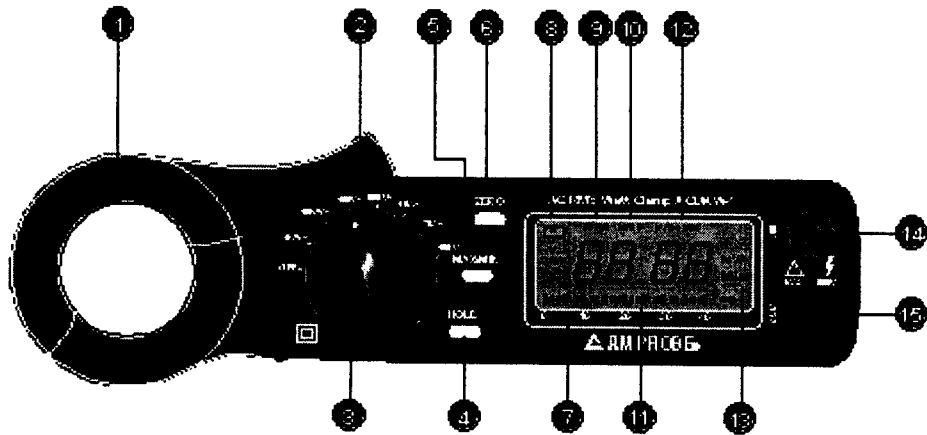

Panel Description

- 1. Transformer Jaw:** This is used to pick up current signal. To measure AC current or AC Power (Watts) conductor must be enclosed by the jaw completely. No gap is allowed.
- 2. Transformer Trigger:** This is used to open the jaw.
- 3. Function Selector and On/Off Switch:** This is used to select the function desired, such as KW, AC/DC V, ACA.
- 4. Data Hold Button:** Once this button is pushed, reading will be held on the LCD. Press again to release it. This button is also used to recover from auto-power-off. Press this button to turn the power back on after auto-power-off.
- 5. Max/Min Hold Button:** This button is used to enable the maximum or minimum value to be displayed and updated during measurement. Press once, minimum value shall be displayed and updated. Press again, maximum value shall be displayed and updated. Press again (the third push), clamp meter return to normal measurement mode. Zero function will be disabled if MAX/MIN is enabled.

Panel Description

- 6. Zero/Relative Button:** Once this button is pressed, the displayed reading shall be set to zero and be used as a zero reference value for all other subsequent measurement. This function is also used to remove offset value caused by temperature for the watt measurement. The Zero/Relative function will be disabled if the MAX/MIN button is pressed.
- 7. LCD:** This is a 3 3/4 digit Liquid Crystal Display with maximum indication of 3999. Function symbols, units, bargraph, sign, decimal points, low battery symbol, max/min symbols, and zero symbol are included.
- 8. Low Battery Symbol:** When this symbol appears, it means the battery voltage has dropped below the minimum required voltage level. Refer to page 10 for battery replacement.
- 9. Zero/Relative Symbol:** When this symbol appears, it means a reference value has been subtracted from the actual reading. The reading shown is a offseted value. Press and hold the zero button for 2 seconds to disable this function.
- 10. Data Hold Symbol:** Once the hold button is pressed, this symbol appears on LCD.
- 11. Bargraph:** Bargraph has forty segments. It displays segments proportional to the actual reading. Each segment represent one hundred counts.
- 12. Max/Min Hold Symbol:** Once the max/min button is pressed, either MAX or MIN shall be displayed on LCD
- 13. Units Symbols:** Once a function is selected, corresponding unit (V or A) shall be displayed on LCD.
- 14. VW Input Terminal:** This terminal is used as input for voltage, or watt measurements.
- 15. COM Terminal:** This terminal is used as common reference input.
- 16. Hand Strap:** Put your hand through the hole of hand strap to avoid accidental drop of the clamp meter.

AC Current Measurement

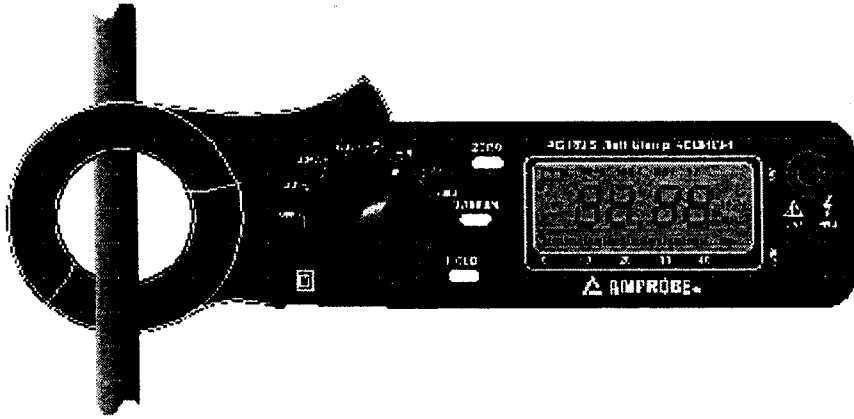

WARNING: Make sure that all the test leads are disconnected from the meter's terminals before making current measurement.

1. AC Voltage

- Set the rotary switch at 40A, or 70A AC
- Press the trigger to open the jaw and fully enclose the conductor to be measured. No air gap is allowed between the two half jaws.
- Read the measured value from the LCD display.

DC/AC Voltage Measurement

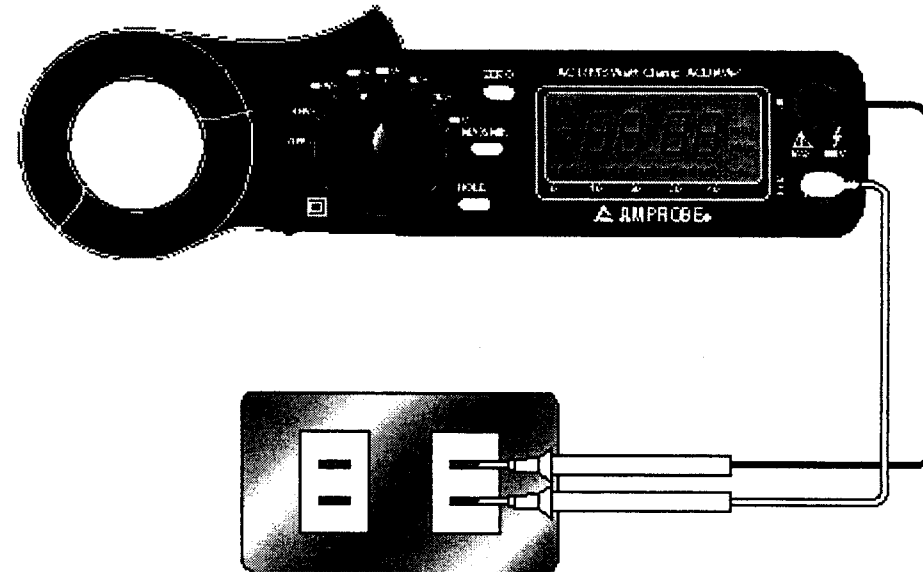

WARNING: Maximum input for DCV or ACV is 800V. Do not attempt to take any voltage measurement that exceeds this limit. Exceeding the limit could cause electrical shock and damage to the clamp meter.

1. DC Voltage

- Set the rotary switch at 400V DC.
- Insert the test leads into the input jack.
- Connect the test prods of the test leads in PARALLEL to the circuit to be measured.
- Read the measured value from the LCD display.

2. AC Voltage

- Set the rotary switch at 400VAC or 600VAC
- Insert the test leads into the input jack.
- Connect the test prods of the test leads in PARALLEL to the circuit to be measured.
- Read the measured value from the LCD display.

AC Single Phase (1 ϕ) Power Measurements

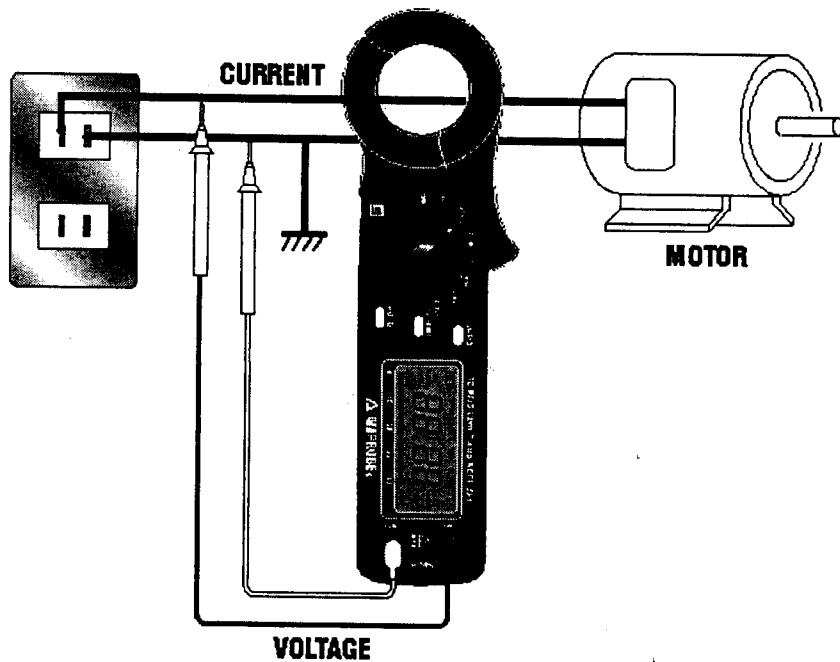
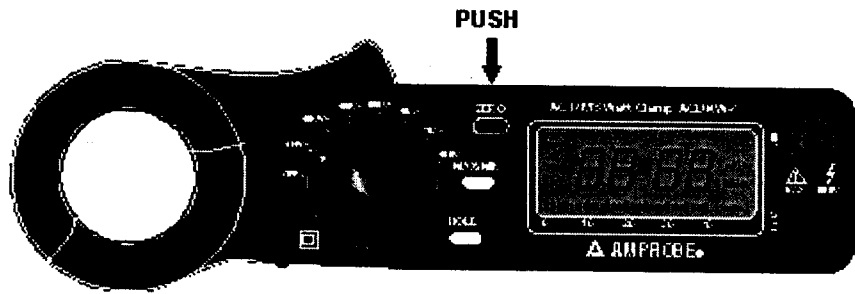

1. Referring to page 6, check the current value (Do not connect test leads).
2. Referring to page 7, check the voltage value.
3. Select appropriate watt range 4KW (0-250V, 0-40A) or 40KW (0-600V, 0-70A).
4. If the reading is not zero, press the ZERO button to zero the watt reading before making any connection to the load to be measured.
5. Connect the test leads to the voltage source.
6. Clamp on the hot wire of the load (not the neutral wire).
7. Read the KW value shown on LCD.

Calculation of Power Factor (PF) for AC Single Phase (1 ϕ) Power

$$PF = \frac{Watt}{V_{rms} A_{rms}}$$

where

- PF: Power factor.
 Watt: AC watt value obtained from page 8.
 V_{rms} : AC voltage true RMS value obtained from page 7.
 A_{rms} : AC current true RMS value obtained from page 6.

Relative Reading Measurements

The zero button also can be used to make a relative measurement. Once the button is pushed, the present reading is set to zero and a zero symbol shall be displayed on LCD. All subsequent measurements shall be displayed as a relative value with respect to the value zeroed. Press the zero button for 2 seconds to return to normal mode. This function is disabled if MAX/MIN function is enabled. Please watch for symbol displayed on LCD.

Holding the LCD Reading

Press the HOLD button, the reading shall be held and kept on LCD.

Finding the Max/Min Value

Press the MAX/MIN button to enable the maximum and minimum values to be recorded and updated during measurement. Push the button once, the minimum value shall be displayed and updated. Push again (second push), the maximum value shall be displayed. Push again (third push), MAX/MIN function shall be disabled and return to the normal measurement mode. If MAX/MIN button is pressed, the ZERO function will be disabled and the ZERO symbol will not be displayed on the LCD.

To Recover from Auto-Power Off

The unit has auto-power-off function. The clamp meter will turn the power off 30 minutes by itself after power-on. To recover, turn the function selector to off, then on again. Or pressing the data hold button can also turn the power back on. To disable auto-power-off function, press and hold the "HOLD" button when turning the power on.

Battery Replacement

When the low battery symbol is displayed on the LCD, replace the old batteries with two new batteries.

1. Turn the power off and remove the test leads from the clamp meter.
2. Remove the screw of the battery compartment.
3. Lift and remove the battery compartment.
4. Remove the old batteries.
5. Insert two new 1.5V SUM-3 (AA Size) batteries.
6. Replace the battery compartment and secure the screw.

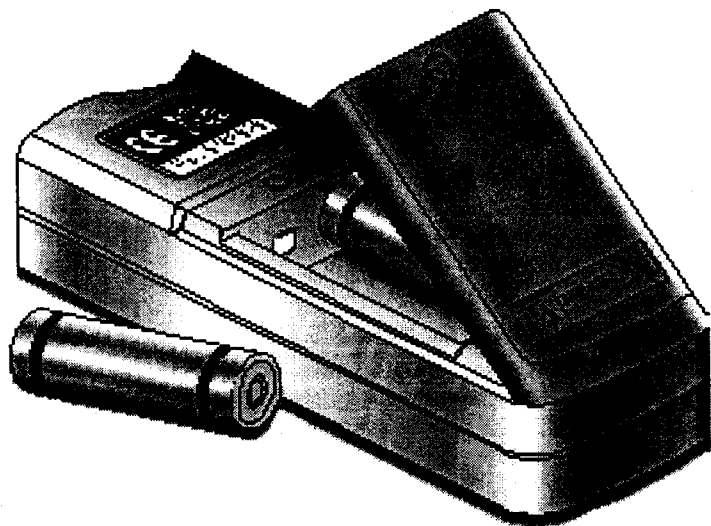

Maintenance & Cleaning

- Servicing not covered in this manual should only be performed by qualified personnel.
- Repairs should only be performed by qualified personnel.
- Periodically wipe the case with a damp cloth and detergent; do not use abrasives or solvents.

Specifications (23°C±5°C)

AC Watt: 50/60Hz, Jaw Phase Shift $\phi < 0.5^\circ$

Range	Resolution	Accuracy	Remarks
AC 4KW	1W	$\pm 2.0\% \text{rdg} \pm 5 \text{dgts}$ $\pm 5^\circ \phi$	0-250V AC, 0-40A, PF 0.3-1.0, 50/60Hz, $V_{\text{peak}} < 360\text{V}$
AC 40KW	10W		0-600V AC, 0-70A, PF 0.3-1.0, 50/60Hz, $V_{\text{peak}} < 850\text{V}$

AC Current: True RMS, Crest Factor < 3.3, Symmetric Signal

Range	Resolution	Accuracy (% of rdg)		Overload Protection
		50/60 Hz	40-400Hz	
40A 70A	10mA 100mA	$\pm 1.5\% \pm 3 \text{dgts}$ $\pm 2.0\% \pm 3 \text{dgts}$	$\pm 2.0\% \pm 4 \text{dgts}$ $\pm 2.5\% \pm 4 \text{dgts}$	AC 400A AC 400A

DC Voltage: Input Impedance: 10M Ω

Range	Resolution	Accuracy (% of rdg)	Overload Protection
400V	0.1V	$\pm 1.0\% \pm 2 \text{dgts}$	DC 800V

AC Voltage: Input Impedance: 10M Ω , True RMS, Crest Factor < 3.3, Symmetric Signal

Range	Resolution	Accuracy (% of rdg)		Overload Protection
		50/60 Hz	40-400Hz	
400V 600V	0.1V 1V	$\pm 1.5\% \pm 3 \text{dgts}$ $\pm 1.5\% \pm 3 \text{dgts}$	$\pm 2.0\% \pm 4 \text{dgts}$ $\pm 2.5\% \pm 4 \text{dgts}$	AC 800V AC 800V

Specifications

Indoor Use

Conductor Size:	1.1" (30mm max. approx.)
Battery Type:	Two 1.5V AA Size (SUM-3)
Display:	3 3/4 digits LCD with 40 seg. bargraph
Range Selection:	Manual
Overload Indication:	Left most digit blinks
Power Consumption:	40 mA (approx.)
Low Battery Indication:	
Auto-Power-Off:	30 minutes after power-on
Sampling Time:	2 times/sec. (display) 20 times/sec. (bargraph)
Operating Temperature:	32°F to 122°F (0°C to 50°C)
Operating Humidity:	Less than 85% relative
Altitude:	> 6500 Ft.
Storage Temperature:	-4°F to 140°F (-20°C to 60°C)
Storage Humidity:	Less than 75% relative
Dimension:	7.2" (L) x 2.5" (W) x 1.4" (H) 210mm (L) x 62mm (W) x 35.6mm (H)
Weight:	6.7 oz. (190g) including batteries
Supplied Accessories:	Carrying bag (1), Users manual (1), 1.5V battery (2), test leads

Appendix 1 - Measurement of Three Phase Three Wire (3φ3W) Power

ACDKW-1 can be used to measure power of three phase three wire (3φ3W) by taking two measurements.

Step 1: Identify the three phase (3φ) and make sure none of them is ground.

Step 2: Measure W_{RS}

- Choose any one phase as a reference ground and connect the black COM terminal of ACDKW-1 to that phase (eg. S phase).
- Connect red VW terminal of ACDKW-1 to one of the other two phases (eg. R phase).
- Clamp on the phase where red VW terminal is connected (eg. R phase).
- The watt value measured is W_{RS}

Step 3: Measure W_{TS}

- Disconnect the red VW terminal and connect red VW terminal to the third phase (eg. T phase).
- Clamp on the phase where red VW terminal is connected (eg. T phase)
- The watt value measured is W_{TS} .

Step 4: Add W_{RS} , and W_{TS} , together. The result equals $W_{3φ}$.

$$W_{3φw} = W_{RS} + W_{TS}$$

Note: When adding W_{RS} and W_{TS} do not take the absolute value of W_{RS} or W_{TS} , because one of W_{RS} or W_{TS} could be negative in such measurement.

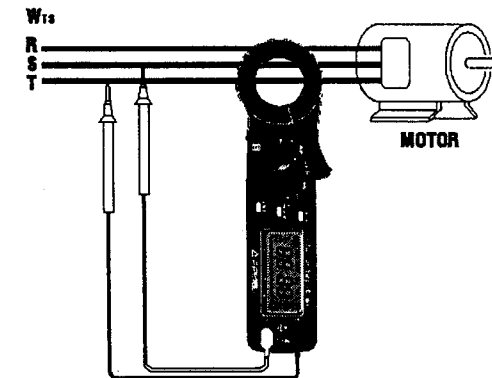
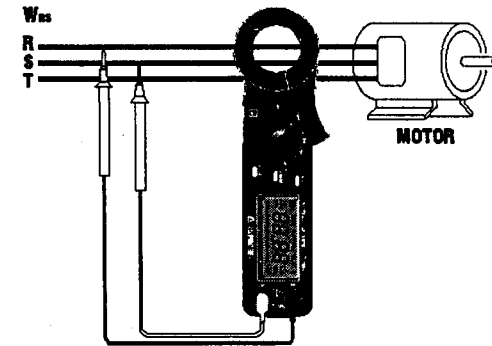

Appendix 2 - Measurement of Three Phase Four Wire (3 ϕ 4W) Power

ACDKW-1 can be used to measure power of three phase four wire (3 ϕ 4W) by taking three measurements.

Step 1: The difference between 3 ϕ 4W and 3 ϕ 3W is that the neutral line is the fourth wire of a 3 ϕ 4W system.

Step 2: Measure W_R

- Connect the neutral wire to the black COM terminal of ACDKW-1
- Connect red VW terminal of ACDKW-1 to one of the three phases (eg. R phase)
- Clamp on the phase where red VW terminal is connected (eg. R phase)
- The watt value measured is W_R .

Step 3: Measure W_S

- Disconnect the red VW terminal and connect red VW terminal to the second phase (eg. S phase)
- Clamp on the phase where red VW terminal is connected (eg. S phase)
- The watt value measured is W_S .

Step 4: Measure W_T

- Disconnect the red VW terminal and connect red VW terminal to the third phase (eg. T phase)
- Clamp on the phase where red VW terminal is connected (eg. T phase)
- The watt value measured is W_T .

Step 5: Add W_R , W_T and W_S together. The result equals $W_{3\phi}$

Note: In measuring 3 ϕ 4W power, any one of W_R , W_S , W_T must be positive. If any one value is negative, the wire connection must be wrong. Check connection of wires to make sure they are connected correctly.

Appendix 2 - Measurement of Three Phase Four Wire (3 ϕ 4W) Power

