

MODEL ACDC-610 DIGITAL AC/DC CLAMP-ON

Measures Current up to 600A AC and DC

FEATURES

- 3½ Digit LCD display, (4000 count)
- Measures ACV/ACA, DCV/DCA, ohms/continuity
- Frequency counter
- Peak hold to measure motor start or surge currents
- Data hold freezes display reading
- Auto power OFF
- Over-range indicator, low battery indicator
- Full annunciated display
- 9V battery, carrying case, test leads and instruction manual included

The Model ACDC-610 is an average sensing instrument, calibrated to give an RMS readout of a sine wave.

SPECIFICATIONS

- Type of Display:** 3½ digits - LCD
Size of Digits: 0.5"
Auto Power Off: 30 minutes after turn on
Over-range indication: "OL"
Ohmmeter Test Voltage: 1.70 VDC
Low Battery Indication: 
Case Voltage Breakdown: 3000V AC/DC
Measurement Rate: 4 times per second minimum
Peak Response Time: 0.08 seconds
Peak Decay Rate: 2 digits max.
Frequency Response: 40-400 Hz
Response Time: Not more than 3.5 seconds
Polarity: Automatic "(-)" negative indication, + implied
Continuity with Buzzer: 0-150Ω + 10%
Frequency Counter: Coupling -AC
Minimum Input Frequency: 20Hz
Minimum Signal Level: 200mV RMS
Maximum Signal Level: 5V RMS
Input Impedance: 10 Megohms
Power Supply: 9 Volt Alkaline
Battery Life: More than 180 hours
Maximum Jaw Opening: 1.65" (4.1 cm)
Maximum Jaw Size: 1.77" (4.5 cm) x 1.57" (4 cm)
Maximum Operating Temperature/Humidity:
 32°F (0°C) to 120°F (49°C) 75% RH
Temperature Coefficient: 0.15 x (Spec. Acc'y)/°C, <18°C or >28°C
Maximum Storage Temperature/Humidity:
 20°F (-6°C) to 140°F (60°C) 80% RH
Functions: DCV, ACV, ACA, DCA,
 OHMS/CONTINUITY, FREQUENCY
 COUNTER, PEAK HOLD, DATA HOLD
Circuit Protection: The frequency and OHMS/Continuity functions are protected to a maximum of 550 volts for not longer than one minute.

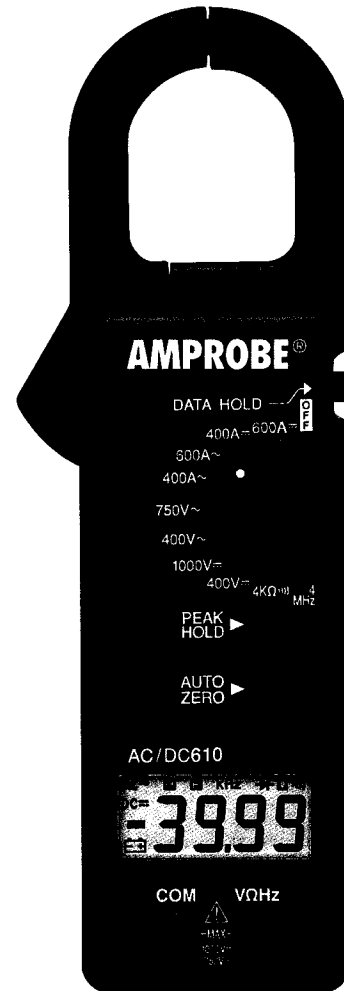

FUNCTION	RANGE	RESOLUTION	ACCURACY	OL PROTECTION
ACV	0-400	0.1	± 1.25% ± 4 LSD	850VRMS
40-400 Hz	0-750	1.0	±1% ± 4 LSD	850VRMS
DCV	0-400	0.1	±0.7% ± 2 LSD	1100 V
	0-1000	1.0	±0.7% ± 2 LSD	1100 V
ACA 40-400 Hz	0-400	0.1	±2.0% ±4 LSD	750 Amps for not more than 1 min.
	400-600	1.0		
DCA	0-400	0.1	±2.0% ±2 LSD	750 Amps for not more than 1 min.
	400-600	1.0		
PEAK HOLD	LO	0.1	± 1.5% ± 5 LSD	1100 VOLTS 700 AMPS
	HI	1.0		
OHMS	0-4K	1.0	± 1% ± 2 LSD	550V AC/DC for 1 min.
FREQUENCY COUNTER	20-4M Hz Auto Ranging	1 Hz	±0.7% ± 3 LSD	550V AC/DC for 1 min.

ACCESSORIES AND REPLACEMENTS

Description	Model #
ACDC-610 Carrying Case	SVPC
Test Leads	DTL-10
Battery (9V)	MN-1604
Alligator Clips	VRC-320
Energizer (increases sensitivity by 10 times AC or DC	A-47L

OPERATING INSTRUCTIONS

for **AMPROBE®** AC/DC Digital Clamp-On Model ACDC-610

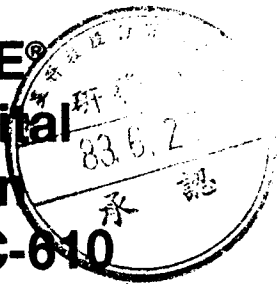
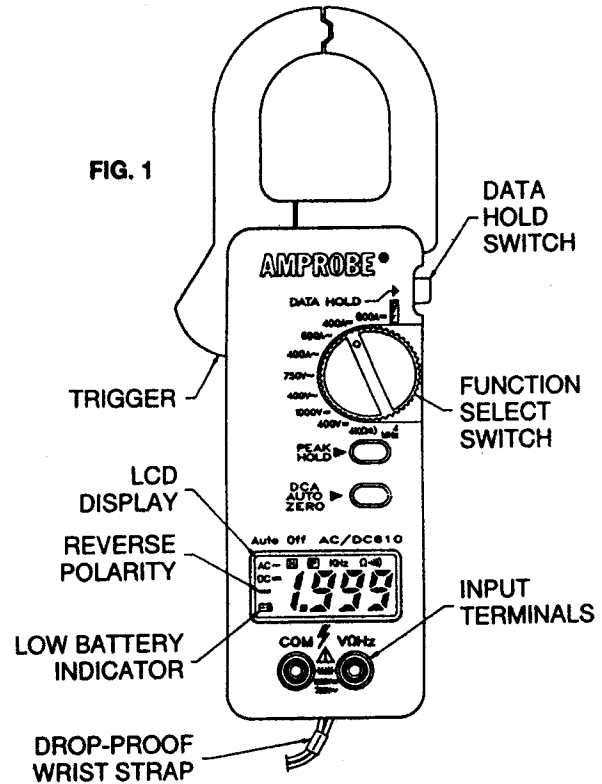

FIG. 1



See "PRECAUTIONS FOR PERSONAL AND INSTRUMENT PROTECTION" on Page 3

See "LIMITED WARRANTY" on Page 2



LIMITED WARRANTY

Congratulations! You are now the owner of an AMPROBE® instrument. It has been quality crafted according to quality standards and contains quality components and workmanship. This instrument has been inspected for proper operation of all of its functions. It has been tested by qualified factory technicians according to the long-established standards of AMPROBE INSTRUMENT.

Your AMPROBE instrument has a limited warranty against defective materials and/or workmanship for one year from the date of purchase provided that, in the opinion of the factory, the instrument has not been tampered with or taken apart.

Should your instrument fail due to defective materials, and/or workmanship during the one-year warranty period, return it along with a copy of your dated bill of sale which must identify instrument by model number and serial number.

For your protection, please use the instrument as soon as possible. If damaged, or should the need arise to return your instrument, it must be securely wrapped (to prevent damage in transit) and sent prepaid via Air Parcel Post insured or UPS where available to:

Service Division
AMPROBE INSTRUMENT
630 Merrick Road (For U.P.S.) • P.O. Box 329 (For
P.P.)
Lynbrook, NY 11563-0329

Outside the U.S.A. the local Amprobe representative will assist you. The above limited warranty covers repair and replacement of instrument only and no other obligation is stated or implied.

PRECAUTIONS FOR PERSONAL AND INSTRUMENT PROTECTION

- 1) Read these instructions thoroughly and follow them carefully.
- 2) In many instances, you will be working with dangerous levels of voltage and/or current. Therefore, it is important that you avoid direct contact with any uninsulated, current-carrying surfaces. Appropriate insulating gloves, clothing and eye protection should be worn.
- 3) To avoid electrical shock to the user and/or damage to the instrument, do not apply more than 1000V between any terminal and ground.
- 4) Before applying test leads to circuit under test, make certain that leads are plugged into proper jacks and switches are set to proper range and function.
- 5) Before using any electrical instruments or tester for actual testing, the unit should be checked on a low energy high impedance source. **Do not use power distribution lines or any other high energy sources.**
- 6) Do not attempt to measure a voltage unless you are already certain that the voltage is below 750 VAC or 1000 VDC. Do not use the 200 mV range unless you are already certain that the voltage is below 500V (AC or DC).
- 7) If the instrument should indicate that voltage is not present in circuit, do not touch circuit until you have checked to see that all instrument switches are in proper position and instrument has been checked on a known live line.
- 8) Make certain no voltage is present in circuit before connecting ohmmeter to circuit.

IMPORTANT: Plug in only one accessory probe or set of test leads at any one time, except as directed.

IMPORTANT: Failure to follow these instructions and/or observe the above precautions may result in personal injury and/or damage to the instrument and/or accessories.

SAFETY

This instruction manual has warnings and safety precautions which must be followed in order to ensure safe operating conditions.

CAUTION

To avoid damage to the meter:

1. Disconnect the test leads from circuit under test before changing functions.
2. Never connect instrument to a voltage source with the rotary switch in the Ohms position.
3. Before taking any reading, be sure that the DATA HOLD and PEAK HOLD switches are in the deactivated or "up" position. Also, check display to verify that these functions are not activated.

Unpacking and Inspection of Contents

Included with the Clamp-On meter should be the following items:

1. Two test leads; one black and one red
2. Instruction Booklet
3. Carrying Case

GENERAL

The model ACDC-610 will directly measure ACV, DCV, ACA, DCA, OHMS and FREQUENCY and provide a digital readout of the value. It is average sensing but calibrated to give an RMS readout of the variable being measured.

Helpful Hints For Getting Top Performance From Your Digital Clamp-On

1. Make Certain Data Hold is off during the measuring process.
2. When measuring Peak AC Amps, be sure to zero adjust instrument on DC Amps first.
3. When measuring currents of widely varying values, start with the conductor in which you expect to find the lowest current, then the next highest, etc. To reduce the possibility of retained magnetism in the jaws, open and close the jaws a few times between measurements.
4. When using the Peak mode to take and lock in a low current measurement that is to be read away from the conductor, open the jaws slowly and then slowly remove them from the conductor.

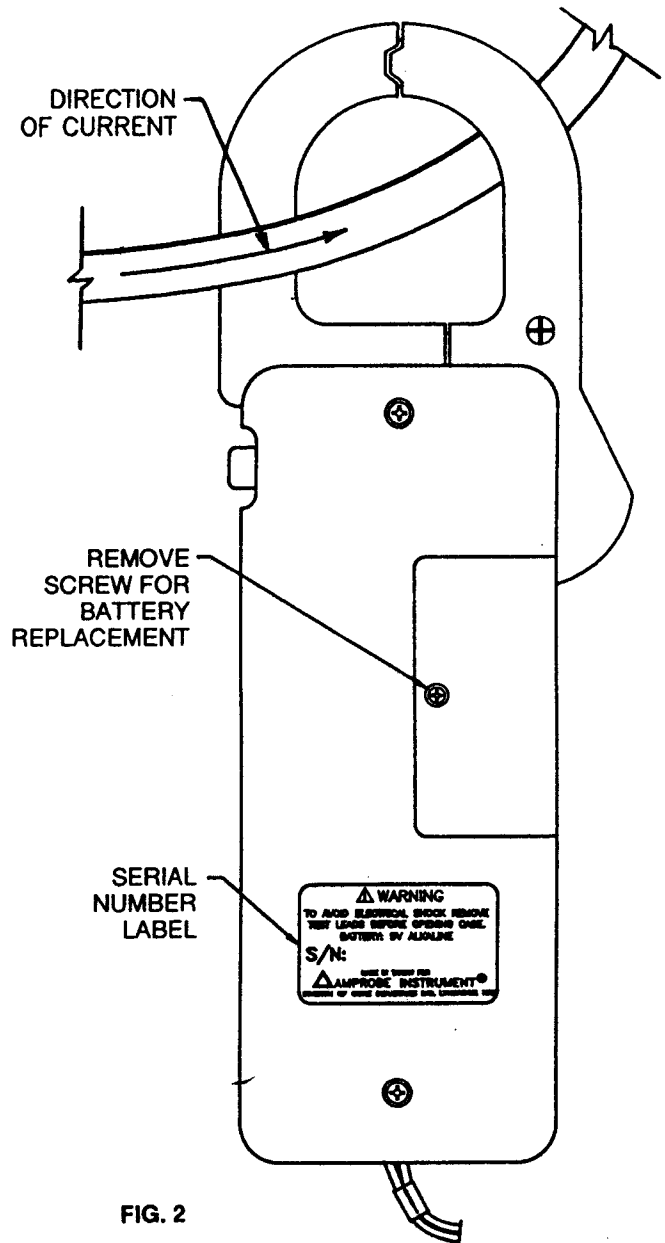

FIG. 2

CIRCUIT PROTECTION

The Frequency and Ohms/Continuity functions are protected to a maximum of 550 Volts for not longer than one minute.

LOW BATTERY INDICATION

Replace the battery when the low battery indication appears in the display. Use an MN1604 9V alkaline battery.

BATTERY INSTALLATION

Remove a single screw from the battery compartment cover and slide cover off by pushing it away from the instrument. Carefully snap a new battery into the connector. Align compartment cover and slide into place. Insert screw and tighten. See Fig. 2.

OVER-RANGE INDICATION

When the input exceeds the range capability, the display will show "OL". Move rotary switch to the next higher range.

When used as an Ohmmeter, resistances higher than 3999Ω will result in an "OL" condition.

DATA HOLD

When Data Hold is activated, an "H" appears in the display. The reading in the display register is locked in and never changes. This is especially helpful when taking a reading in hard-to-reach or poorly lit areas. Just press the button and remove the instrument to an area where it can be easily read. The reading is held indefinitely. Press again to deactivate.

SPECIFICATIONS FOR ACDC-610

Type of Display: 3 3/4 digits - LCD

Size of Digits: 0.5"

Auto Power Off: 30 minutes after turn on

Over-range Indication: "OL"

Ohmmeter Test Voltage: 1.70 VDC

Low Battery Indication: 

Case Voltage Breakdown: 3000V AC/DC

Measurement Rate: 2 times per second minimum

Peak Response Time: 0.08 seconds

Peak Decay Rate: 2 digits max.

Frequency Response: 40-400Hz

Response Time: Not more than 3.5 seconds

Functions : DCV, ACV, ACA, DCA,

OHMS/CONTINUITY, FREQUENCY
COUNTER, PEAK HOLD, DATA HOLD

FUNCTION	RANGE	RESOLUTION	ACCURACY	OL PROTECTION
ACV 40-400Hz	0-400	0.1	±1.25% ± 4LSD	850VRMS
	0-750	1.0	± 1% ± 4LSD	850VRMS
DCV	0-400	0.1	±0.7% ± 2LSD	1100V
	0-1000	1.0	±0.7% ± 2LSD	1100V
ACA 40-400Hz	0-400	0.1	±2.0% ± 4LSD	750Amps for not more than 1 min
	400-600	1.0		
DCA	0-400	0.1	±2.0% ± 2LSD	750Amps for not more than 1 min.
	400-600	1.0		
PEAK HOLD	LO	0.1	±1.5% ± 5LSD	1100VOLTS 700AMPS
	HI	1.0		
OHMS	0-4K	1.0	±1% ± 2LSD	550V AC/DC for 1 min.
FREQUENCY COUNTER	20Hz- 4M Hz	1Hz	±0.7% ± 3LSD	550V AC/DC for 1 min.

Polarity: Automatic "-" negative indication

Continuity with Buzzer: 0-150 Ω ±10%

Frequency Counter: Coupling-AC

Min. Input Frequency: 20Hz

Minimum signal level: 200mV RMS

Maximum signal level: 5V RMS

Input Impedance : 10 Megohms

Power Supply : 9 Volt Alkaline

Battery Life : More than 180 hours

Maximum Jaw Opening : 1.65" (4.1cm)

Maximum Jaw Size : 1.77" (4.5cm) x 1.57" (4cm)

Maximum Operating Temperature / Humidity :

32°F (0°C) to 120°F (50°C) 75%RH

Maximum Storage Temperature / Humidity :

20°F (-6°C) to 140°F (60°C) 80%RH

Temperature Coefficient :

0.15 x (Spec.Acc'y) / °C, < 18°C or > 28°C

HOW TO MEASURE AC OR DC VOLTAGE

⚠ WARNING! DO NOT exceed 1100 VDC or 850 VRMS on any Voltage range

IMPORTANT

See "PRECAUTIONS FOR PERSONAL AND INSTRUMENT PROTECTION"

1. Be sure the Data and Peak Hold switches are in the "UP" or deactivated position.
2. Insert voltage test leads, black to "COM" and red to "VΩ Hz" jacks.
3. Move rotary switch to appropriate function and range.
4. Apply test leads to points of circuit to be measured.
5. If an "OL" indication should appear in the display, move the rotary switch to a higher range.
6. For DC voltage; if a "-" minus sign appears in the left side of the display, reverse the test leads.
7. The Data Hold function can now be activated if so desired.

Note: Periodic check on safety leads can be made by shorting lead and checking continuity.

HOW TO MEASURE RESISTANCE

⚠ WARNING! DO NOT apply any voltage between these terminals when function switch is set to measure resistance.

IMPORTANT

See "PRECAUTIONS FOR PERSONAL AND INSTRUMENT PROTECTION"

1. Be sure the Data and Peak Hold switches are in the "UP" or deactivated position.
2. Insert test leads, black to "COM" and red to "VΩ Hz" jacks.
3. Move rotary switch to 4KΩ resistance range.
4. Apply test leads to resistance to be measured.
5. For resistance from 0-150Ω ± 10%, sound will be heard from the continuity buzzer.

Note: Resistance range is overload protected for up to 550V for not longer than one minute.

HOW TO MEASURE AC OR DC CURRENT

IMPORTANT

See "PRECAUTIONS FOR PERSONAL AND INSTRUMENT PROTECTION"

1. Be sure the Data and Peak Hold switches are in the "UP" or deactivated position.
2. Disconnect voltage test leads if connected to the instrument.
3. Turn instrument on by moving rotary switch to the desired range and function.
4. If DC Amps is selected, be sure to zero adjust first. With jaws closed and away from conductor, continue to press DCA AUTO ZERO Button until instrument reads all zeroes or very close to it.
5. Encircle conductor with jaws of instrument.
6. Release finger pressure on trigger and allow jaws to close around the conductor.
7. If an "OL" indication appears in the display, move rotary switch to the next higher range.
8. The Data Hold function can now be activated if so desired.

Note: If more than one DC Amp measurement is to be made, the instrument should be zeroed away from the conductor before each subsequent measurement. See (4) above for zeroing procedure. "-" Will appear in the display if direction of current is not as in Fig. 2.

HOW TO MEASURE PEAK (SURGE) CURRENT

IMPORTANT

See "PRECAUTIONS FOR PERSONAL AND INSTRUMENT PROTECTION"

1. Be sure the Data and Peak Hold switches are in the "UP" or deactivated position.
2. Disconnect voltage test leads if connected to the instrument.
3. Turn instrument on by moving to either of the two DC Amp ranges, depending on resolution desired.

4. With jaws closed and away from conductor, continue to press DC AUTO ZERO Button until instrument reads all zeroes or very close to it.
5. Move rotary knob to the appropriate AC Amp range.
6. Press the Peak Hold button. "P" will now be visible in the display.
7. Encircle the conductor with jaws of the instrument.
8. Release finger pressure on trigger and allow the jaws to gently close around the conductor.

Note: 1. If an "OL" appears in the display, the range capability was exceeded.

2. Peak or Surge must last for at least .08 seconds.

3. For Peak measurement, instrument must be zeroed on DC first, then switched to AC Amps.

HOW TO MEASURE FREQUENCY

IMPORTANT

See "PRECAUTIONS FOR PERSONAL AND INSTRUMENT PROTECTION"

Caution: DO NOT apply voltage to input terminals while instrument is in the Frequency measuring mode.

1. Be sure the Data and Peak Hold switches are in the "UP" or deactivated position.
2. Insert test leads, black to "COM" and red to "VΩHz" jacks.
3. Move rotary switch to 4M-Hz position.
4. Connect test leads to signal source to be measured.

Note: Amplitude level of signal source has to be a minimum of 100mV for sine waves and 30mV peak for square waves.

REPLACEMENT PARTS

Test LeadsCat. # DTL-10
 Carrying CaseCat. # SVPC
 BatteryCat. # MN1604

SERVICE

Serial number is located on the back label of the instrument. For factory service, package instrument and packing slip with sufficient cushioning material in a shipping carton; make certain your name and address also appears on box as well as packing slip; ship prepaid via U.P.S. (where available) or Air Parcel Post insured to:

Service Division
 AMPROBE INSTRUMENT
 630 Merrick Road (Use for U.P.S.)
 P.O. Box 329 (Use for Parcel Post)
 Lynbrook, NY 11563-0329

Outside the U.S.A. the local Amprobe representative will assist you.

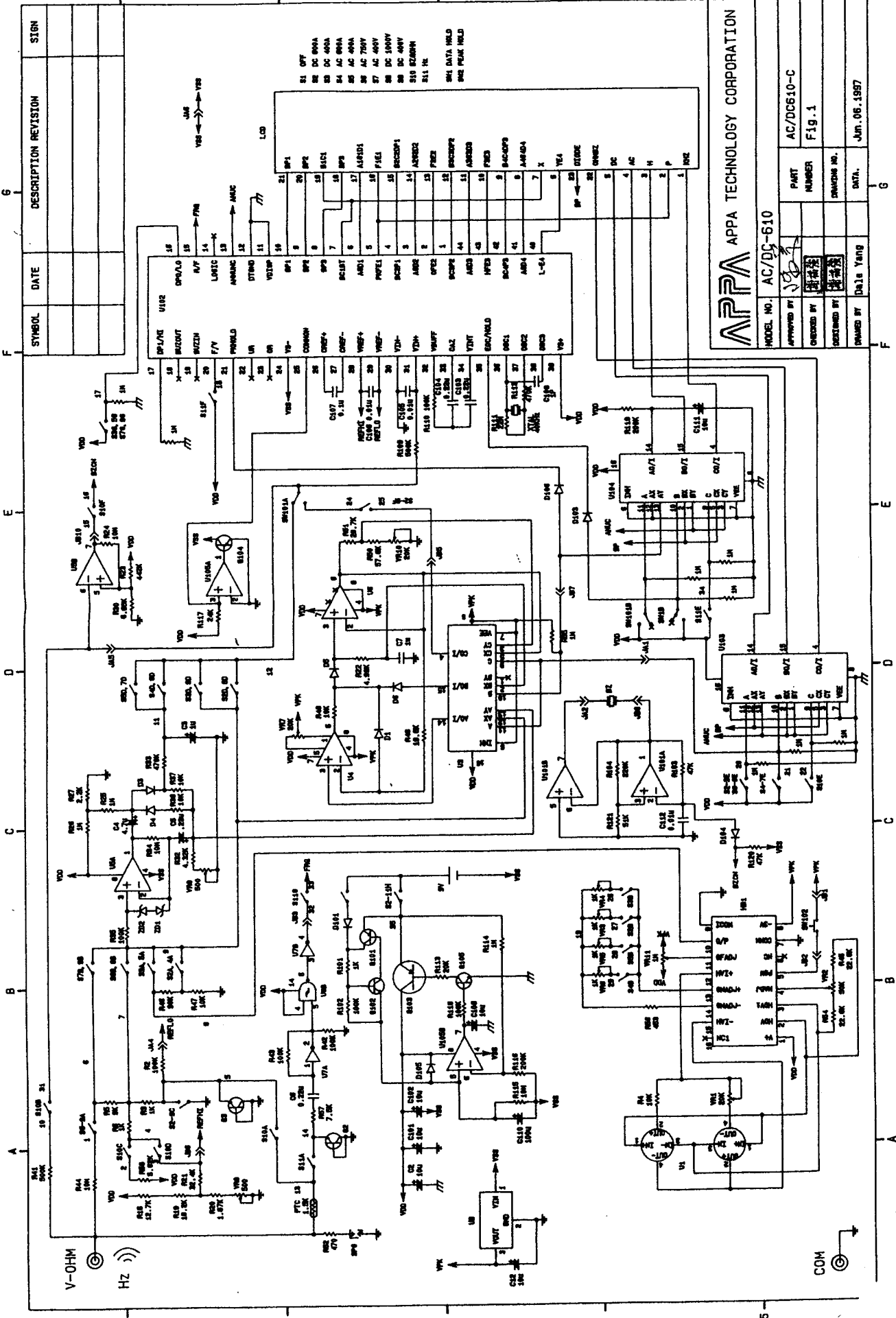

SYMBOL	DATE	DESCRIPTION	REVISION	SIGN

- 21 0P1
- 22 DC 000A
- 23 DC 000A
- 24 AC 000A
- 25 AC 000A
- 26 AC 750V
- 27 AC 000V
- 28 DC 300V
- 29 DC 000V
- 30 02000H
- 31 1H
- 32 0P1
- 33 0P2
- 34 0P3
- 35 0P4
- 36 0P5
- 37 0P6
- 38 0P7
- 39 0P8
- 40 0P9
- 41 0P10
- 42 0P11
- 43 0P12
- 44 0P13
- 45 0P14
- 46 0P15
- 47 0P16
- 48 0P17
- 49 0P18
- 50 0P19
- 51 0P20
- 52 0P21
- 53 0P22
- 54 0P23
- 55 0P24
- 56 0P25
- 57 0P26
- 58 0P27
- 59 0P28
- 60 0P29
- 61 0P30
- 62 0P31
- 63 0P32
- 64 0P33
- 65 0P34
- 66 0P35
- 67 0P36
- 68 0P37
- 69 0P38
- 70 0P39
- 71 0P40
- 72 0P41
- 73 0P42
- 74 0P43
- 75 0P44
- 76 0P45
- 77 0P46
- 78 0P47
- 79 0P48
- 80 0P49
- 81 0P50
- 82 0P51
- 83 0P52
- 84 0P53
- 85 0P54
- 86 0P55
- 87 0P56
- 88 0P57
- 89 0P58
- 90 0P59
- 91 0P60
- 92 0P61
- 93 0P62
- 94 0P63
- 95 0P64
- 96 0P65
- 97 0P66
- 98 0P67
- 99 0P68
- 100 0P69
- 101 0P70
- 102 0P71
- 103 0P72
- 104 0P73
- 105 0P74
- 106 0P75
- 107 0P76
- 108 0P77
- 109 0P78
- 110 0P79
- 111 0P80
- 112 0P81
- 113 0P82
- 114 0P83
- 115 0P84
- 116 0P85
- 117 0P86
- 118 0P87
- 119 0P88
- 120 0P89
- 121 0P90
- 122 0P91
- 123 0P92
- 124 0P93
- 125 0P94
- 126 0P95
- 127 0P96
- 128 0P97
- 129 0P98
- 130 0P99
- 131 0P100

APPA APPA TECHNOLOGY CORPORATION

MODEL NO. AC/DC-610

APPROVED BY: [Signature]

CHECKED BY: [Signature]

DESIGNED BY: [Signature]

DRAWN BY: DALE YARD

DATE: JAN. 06. 1987

PART NUMBER: AC/DC610-C

FIG. 1

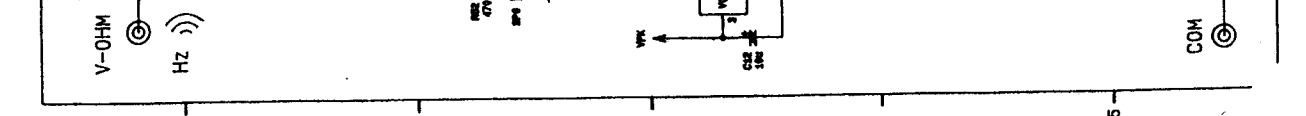

Recalibrate your meter:

It is recommended that the multimeter be calibrated once each year.

Use the following procedure to calibrate the multimeter:

1. Perform calibration at an ambient temperature of $23^{\circ}\text{C} \pm 2^{\circ}\text{C}$ and a relative humidity of 75% or less.
Allow instrument to sit at this temperature for at least thirty minutes.
2. Disconnect the test leads and turn the meter off. Remove the test leads from the front terminals.
3. Position the meter face down. Remove the three screws from the case bottom.
4. Lift the end of the case bottom until it gently unsnaps from the case top at the end nearest the LCD.
5. Lift the circuit board from the case top. DO not remove the screws from the circuit board.

(A) DCV Calibration (Adjust VR9)

6. Set the " . " on the rotary selector to the "DC 400V" position on the PCB.
7. Set the output of DCV calibrator for $390.0\text{V} \pm 0.02\%$ and connect to V- Ω and COM input terminals on instrument.
8. Using a small flat-tipped screwdriver adjust the potentiometer VR9 until the display reads 390.0 or 390.1 .
9. Disconnect the DCV calibrator from the instrument.

(B) ACV Calibration (Adjust VR8)

10. Set the " . " on the rotary selector to the "AC 400V" position on the PCB.
11. Set the output of ACV calibrator for $390.0\text{V} \pm 0.02\%$ 500Hz and connect to V- Ω and COM input terminals on instrument.
12. Using a small flat-tipped screwdriver adjust the potentiometer VR8 until the display reads 390.0 or 390.1 .
13. Disconnect the ACV calibrator from the instrument.

(C) Peak Hold Zero Calibration (Adjust VR10, VR7)

14. Set the " . " on the rotay selector to the "DC 400V" position on the PCB.

機種	AC/DC 610	版別	A	頁數	1
設	83.7.25	檢	83.7.26	檢	83.7.27

Using a small flat-tipped screwdriver adjust VR10 to lowest side.

16. Short the V-Ω and COM of the instrument.
17. Short the points marked a "PK" symbol between them.
18. Using a small flat-tipped screwdriver adjust VR7 until the display shows 00.0 .

(D) Peak Hold Calibration (Adjust VR10)

19. Set the " . " on the rotary selector to "AC 400V" position on the PCB.
20. Using a small flat-tipped screwdriver adjust VR10 to its upper side.
21. Set the output of ACV calibration for $200.0V \pm 0.02\%$ 500Hz and connect to the V-Ω and COM on the instrument.
22. Press the peak hold key and wait until the "P" symbol appeared.
23. Using a small flat-tipped screwdriver adjust VR10 until the display shows 200.0 or + 3 digits.
24. Disconnect the ACV calibrator from the instrument.

(E) Position Error calibration (Adjust VR1)

25. Set the " . " on the rotary selector to the "AC 400A" position on the PCB.
26. Flow the current of AC 380A/120Hz around the suitable wire or conductor.
27. Open spring-loaded clamp by pressing trigger on the left side of instrument
28. Position clamp around wire or conductor and release trigger to make sure the clamp is entirely closed.
29. Using a small flat-tipped screwdriver adjust the VR1 until the error is limited under 1% while position the carry current wire up to clamp and down to the clamp.
30. Disposition the clamp from the wire or conductor.

(F) DCA Zero Calibration (Adjust VR2, VR11)

31. Set the " . " on the rotary selector to the "DC 400A" position.
32. Short the points marked "A" and "B" on the bottom PCB (750-2 □).
33. Using a small flat-tipped screwdriver adjust VR2 until the display shows 00.0 ± 5 digits.

機種 AC/DC 610	版別 A	頁數 7
設 83.7.25	83.7.26	83.7.27

34. Disshort the points marked "A" and "B".
35. Using a small flat-tipped screwdriver adjust VR11 until the display shows 00.0 after pressing the DCA AUTO ZERO key.
- (G) AC 400A Range Calibration (Adjust VR6)
36. Set the " . " on the rotary selector to the "AC 400A" position on the PCB.
37. Flow the current of AC $200.0A \pm 0.02\%$ 120Hz around the suitable wire or conductor.
38. Position clamp around the wire or conductor, release clamp trigger to make sure the clamp is entirely closed.
39. Reposition the clamp to make the wire or conductor is in the center of the clamp.
40. Using a small flat-tipped screwdriver adjust VR6 until display shows 200.0 .
41. Disposition the clamp from the wire or conductor.
- (H) AC 600A Range calibration (Adjuse VR5)
42. Set the " . " on the rotary selector to the "AC 600A" position on the PCB.
43. Flow the current of AC $300A \pm 0.02\%$ 120Hz around the suitable wire or conductor.
44. Position clamp around the wire or conductor, release clamp trigger to make sure the clamp is entirely closed.
45. Reposition the clamp to make the wire or conductor is in the center of the clamp.
46. Using a small flat-tipped screwdriver adjust VR5 until the display shows 300.
47. Disposition the clamp from the wire or conductor.
- (I) DC 400A Range Calibration (Adjust VR4)
48. Set the " . " on the rotary selector to the "DC 400A" position on the PCB.
49. Flow the current of DC $200.0A \pm 0.02\%$ around the suitable wire or conductor.
50. Position clamp around the wire or conductor, release clamp trigger to make sure the clamp is entirely closed.

機種 AC/DC 610	版別 A	頁數 3
--------------------	---------	---------

設計 83.7.25	校對 83.7.26	核准 83.7.27
主編 陳文宗	校對 陳文宗	核准 吳仁全

AC

51. Fully compensate the extra magnetic effect of DC 200A current by pressing the DCA AUTO ZERO key.
52. Reposition the clamp to make the wire or conductor is in the center of the clamp.
53. Using a small flat-tipped screwdriver adjust the VR4 until the display shows 200.0 .
54. Disposition the clamp from the wire or conductor.
- (J) DC 600A Range Calibration (Adjust VR3)
55. Set the " . " on the rotary selector to the "DC 600A" position on the PCB.
56. Flow the current of DC $300.0A \pm 0.02\%$ around the suitable wire or conductor.
57. Position clamp around the wire or conductor, release clamp trigger to make sure the clamp is entirely closed.
58. Fully compensate the extra magnetic effect of DC 300A current by pressing the DCA AUTO ZERO key.
59. Reposition the clamp to make the wire or conductor is in the center of the clamp.
60. Using a small flat-tipped screwdriver adjust VR3 until the display shows 300.

機種	AC/DC 610	版別	A	頁數	4
----	--------------	----	---	----	---

設計	83.7.25	審核	83.7.26	檢閱	83.7.26
----	---------	----	---------	----	---------